

Shape Activities

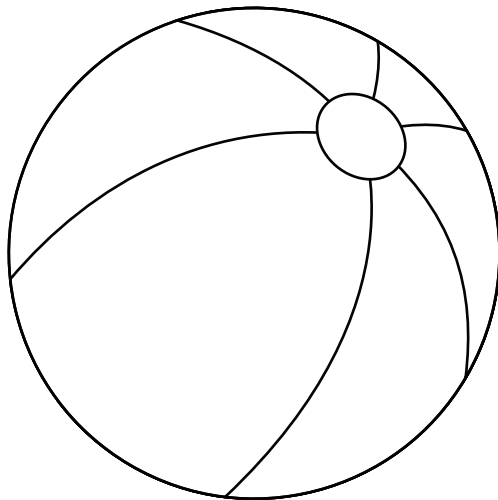

CIRCLE

Circle

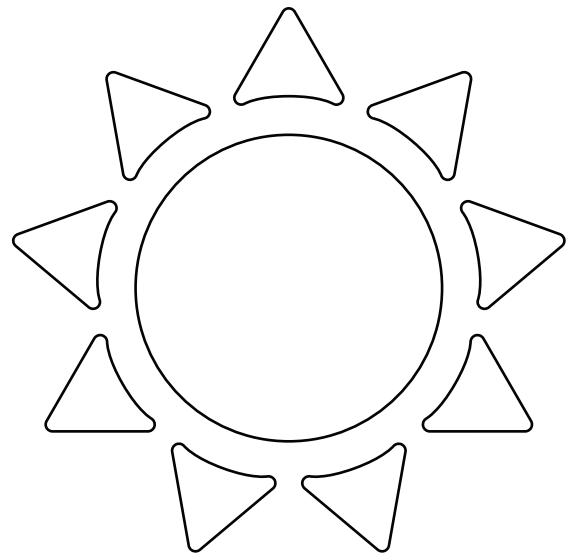
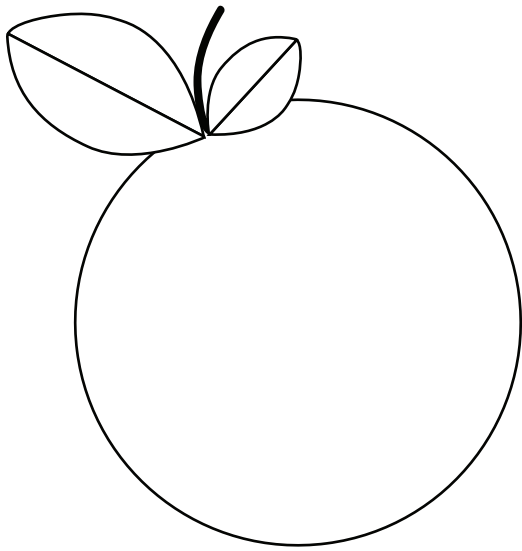
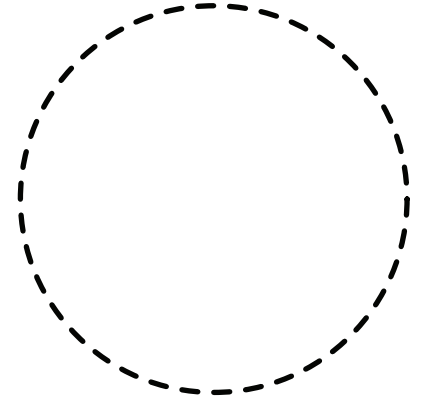

TRIANGLE

Triangle

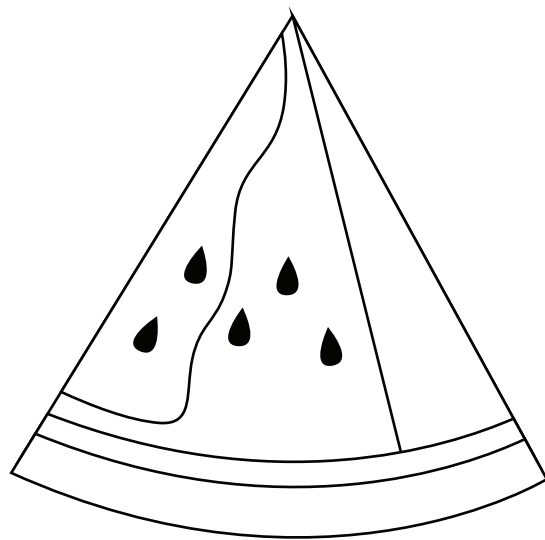
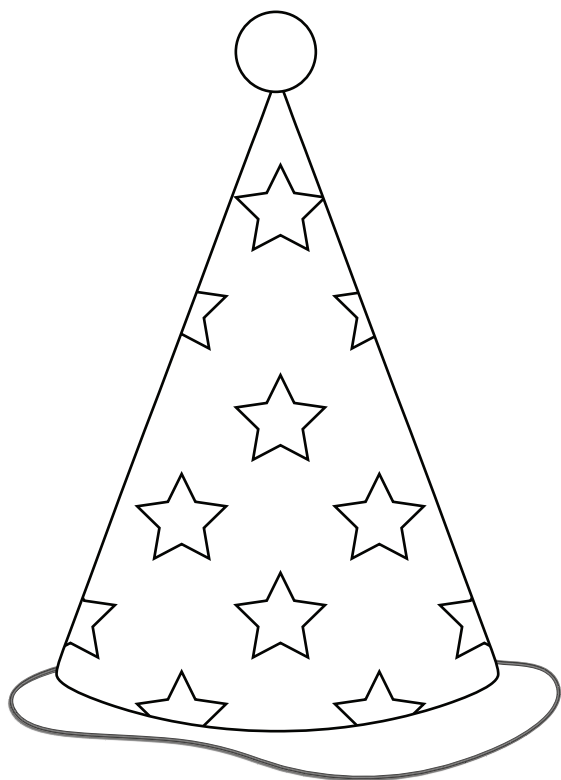
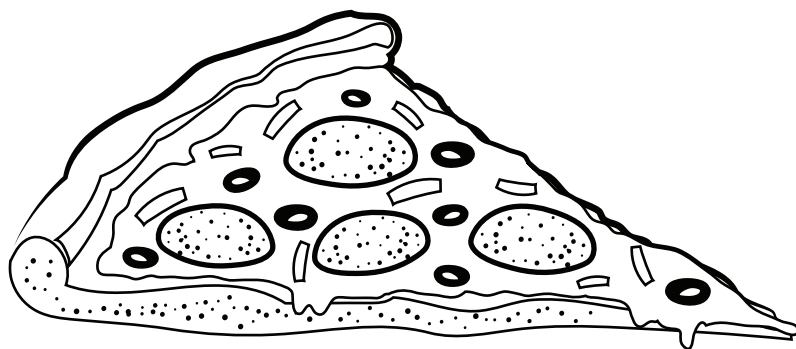

SQUARE

Square

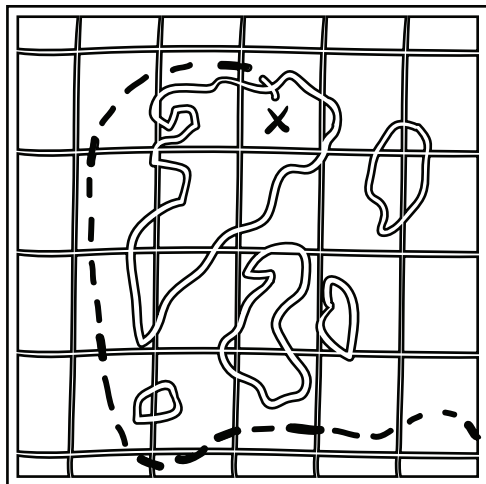
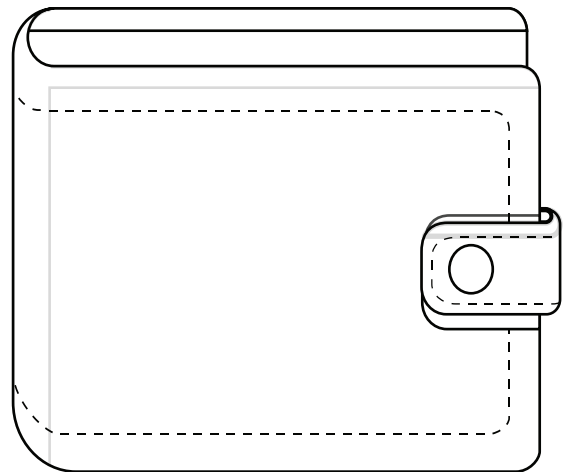
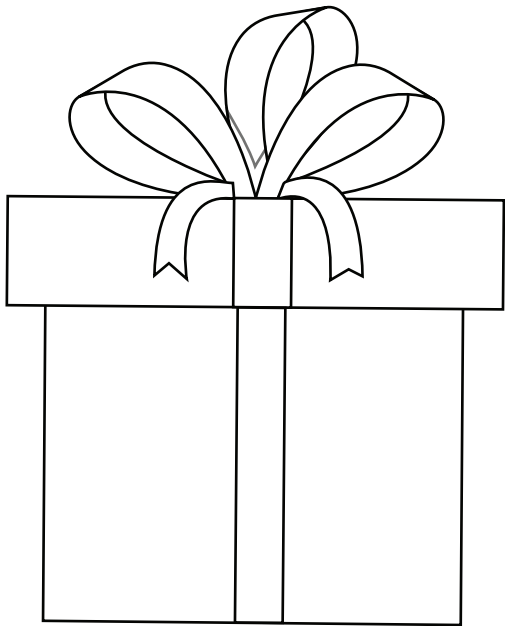
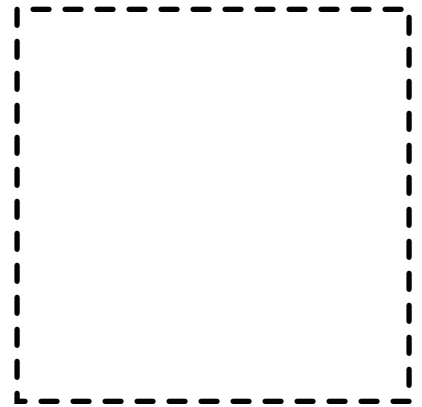

RECTANGLE

Rectangle

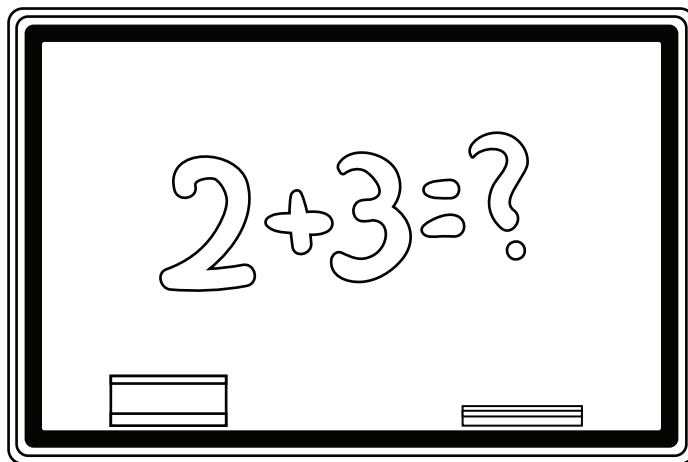
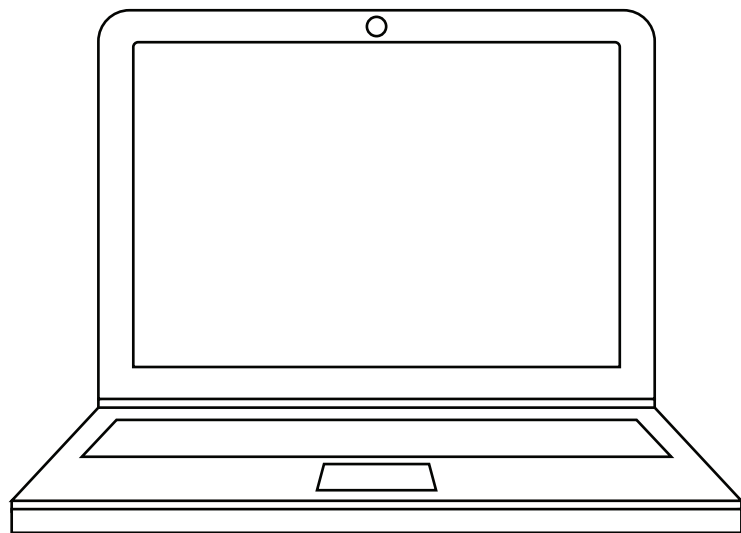
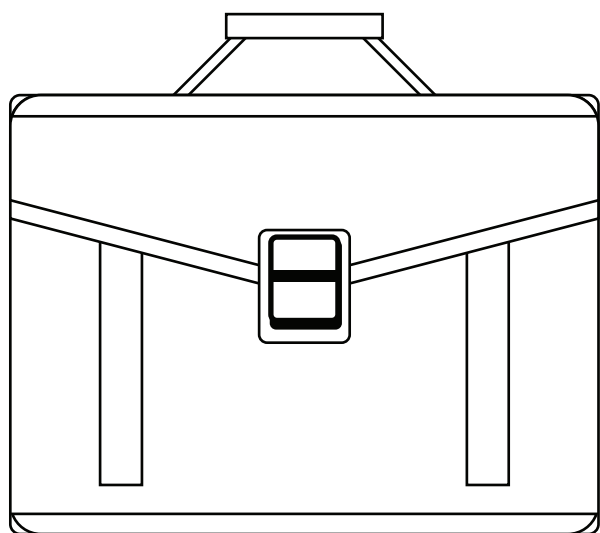

OVAL

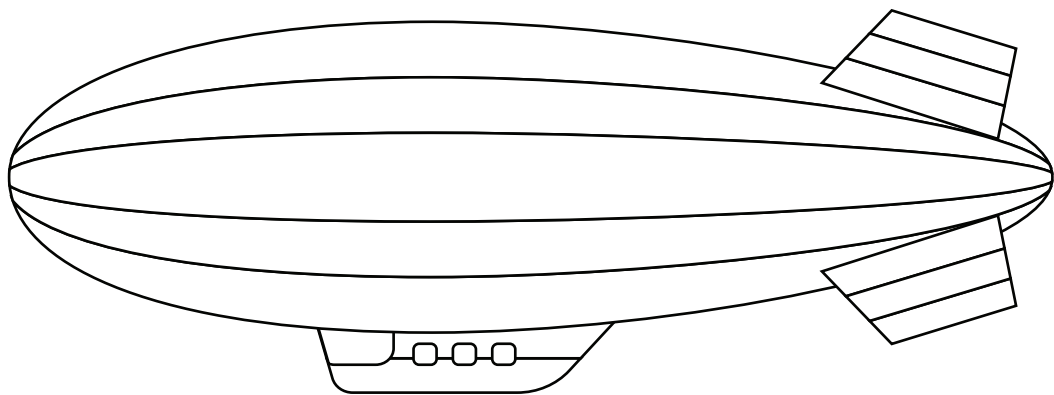
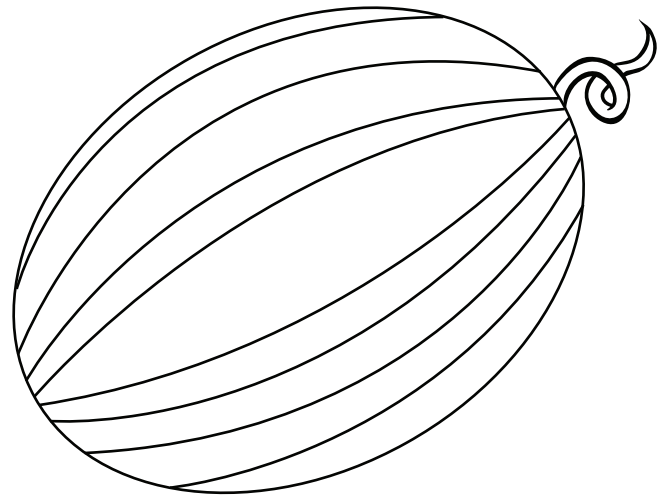
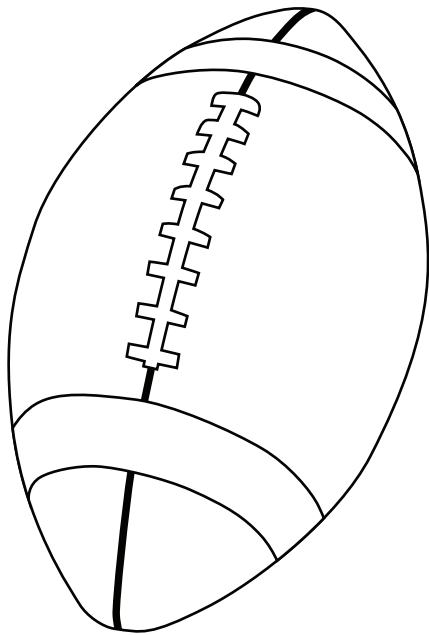
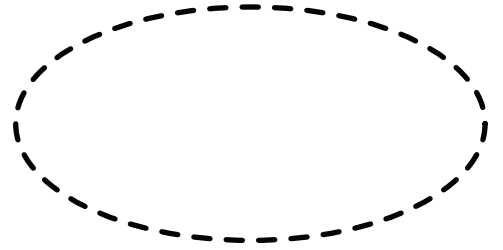
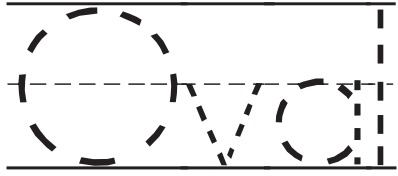

DIAMOND

D.
Diamond

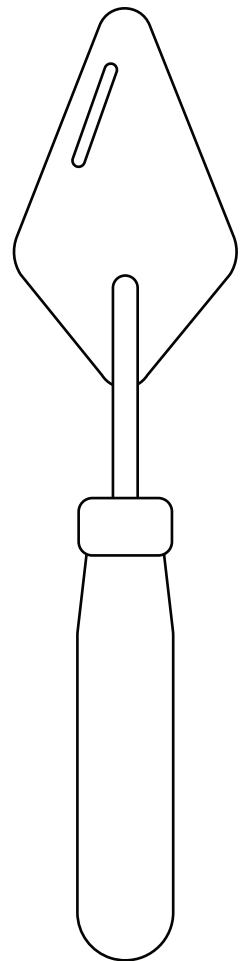
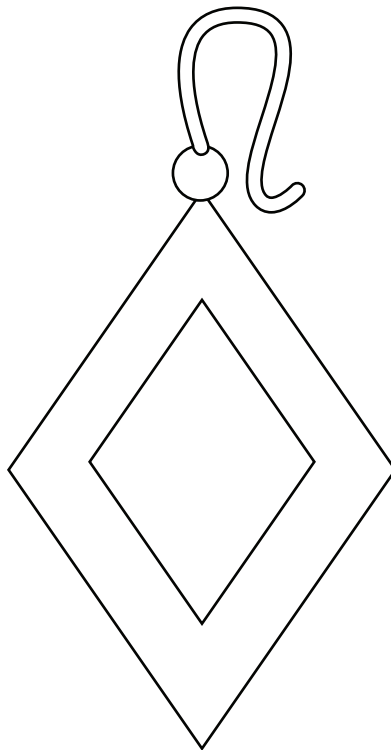
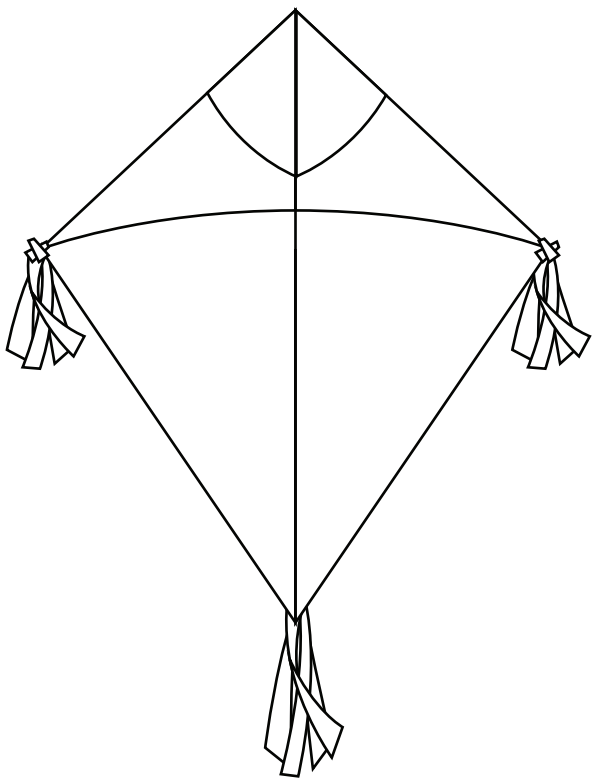
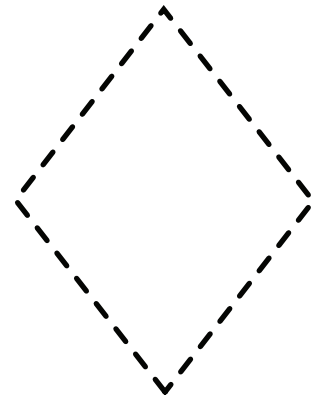

HEXAGON

Hexagon

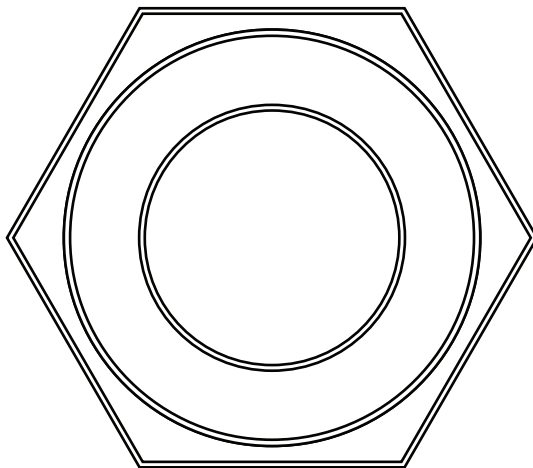
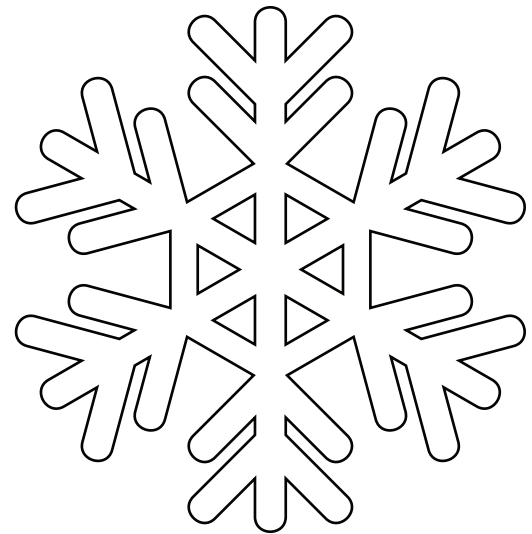
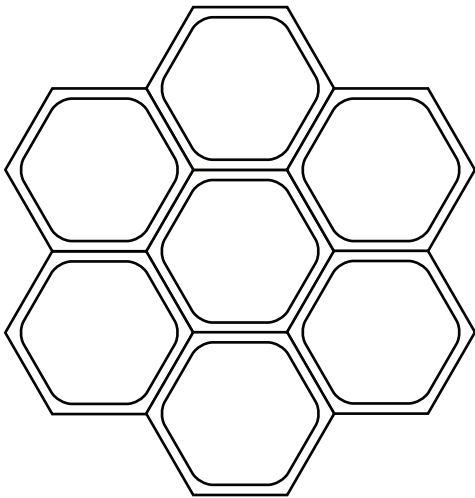
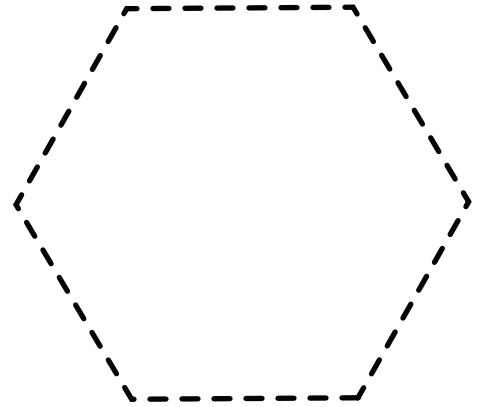

STAR

Star

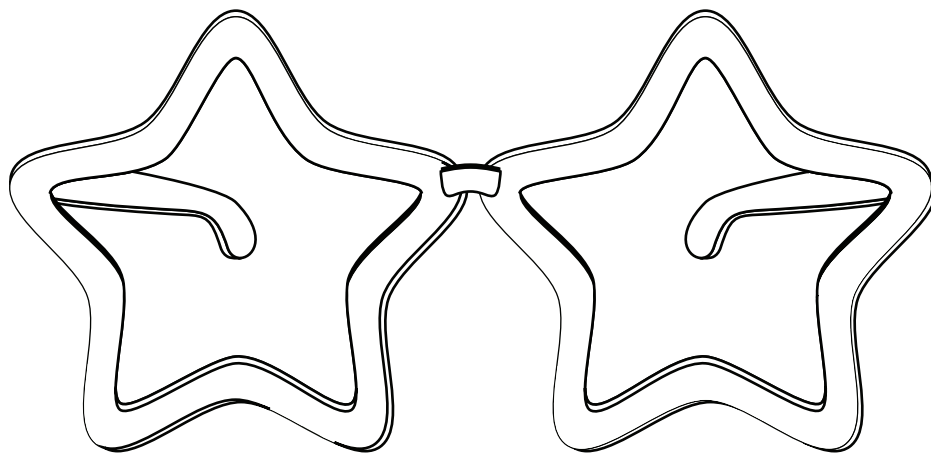
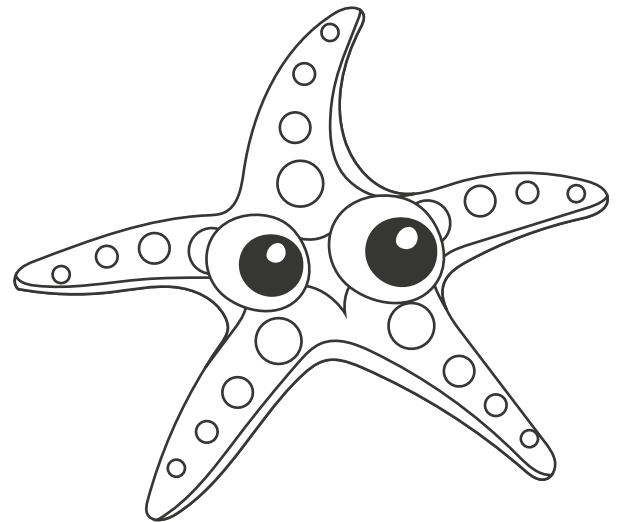
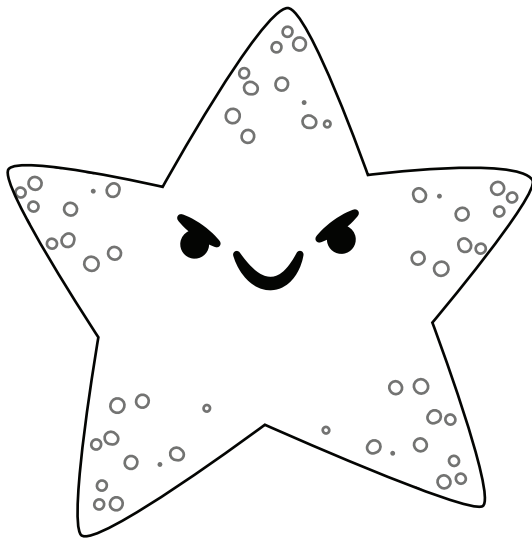
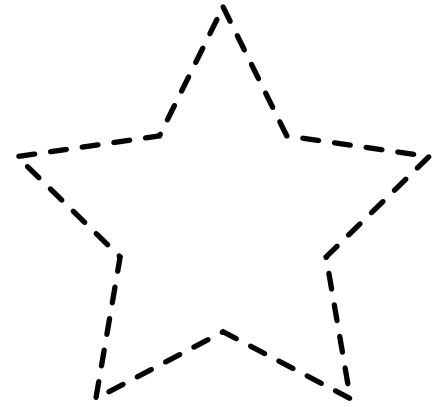

HEART

Heart

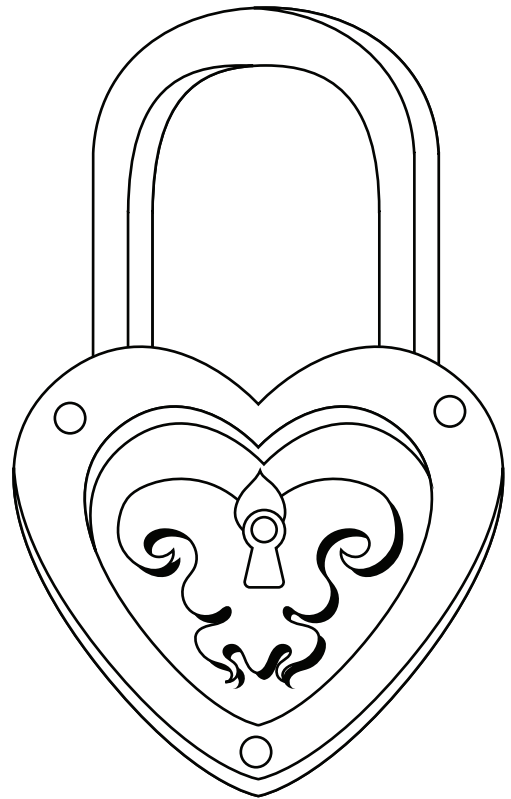
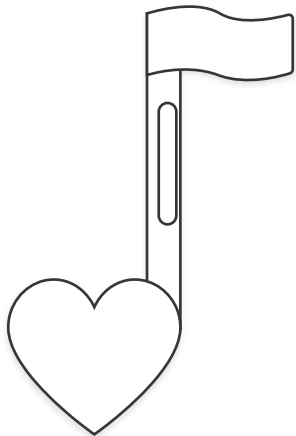
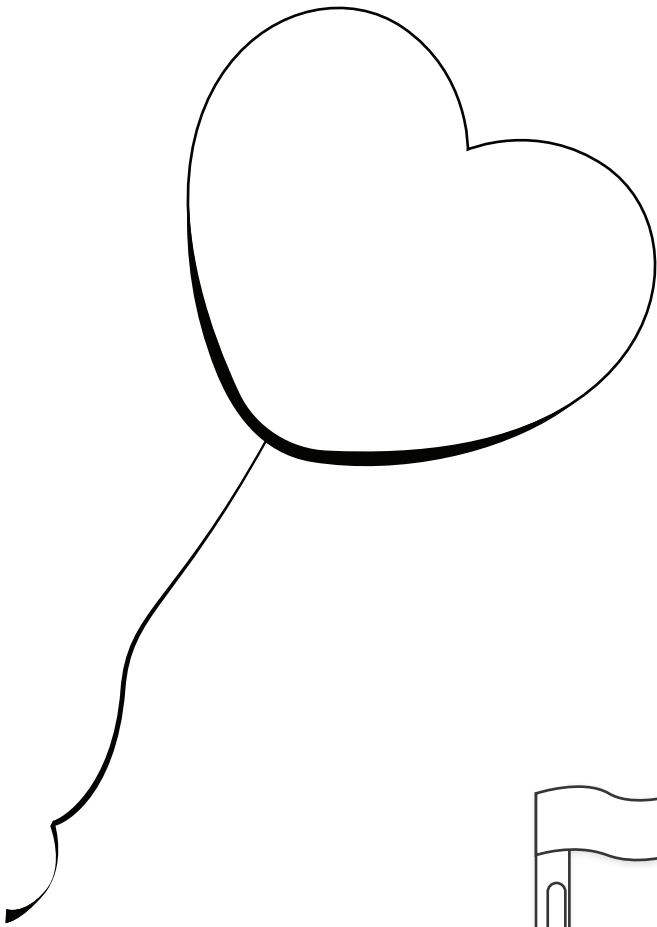

Circle the Circle Things

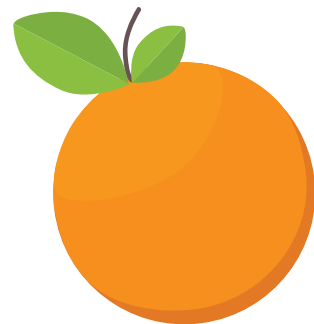
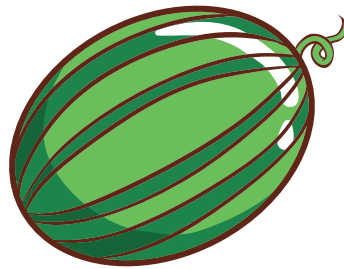
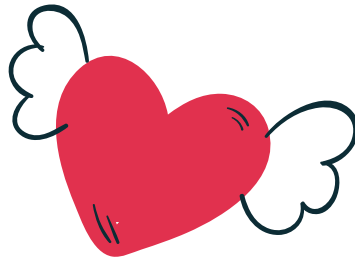
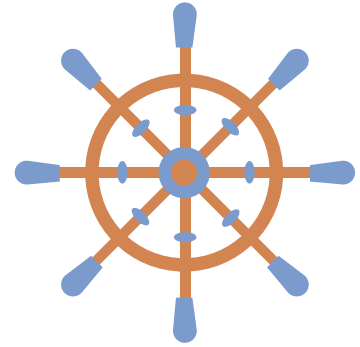
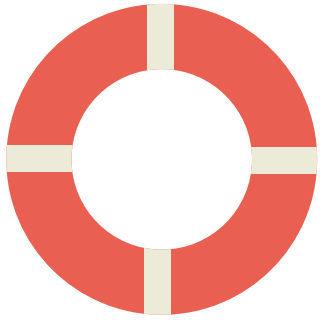

Circle the Triangle Things

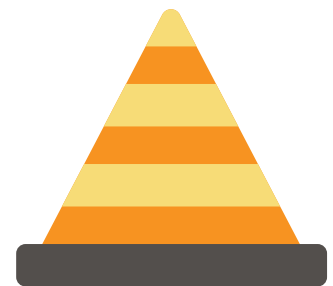
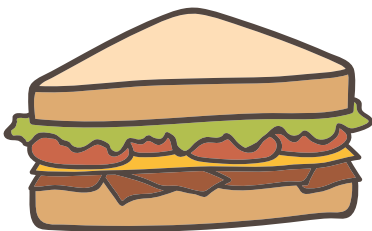
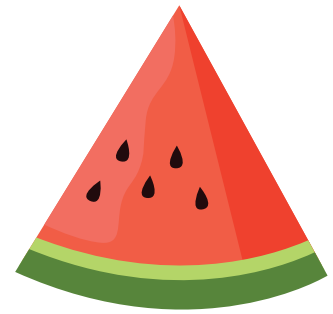
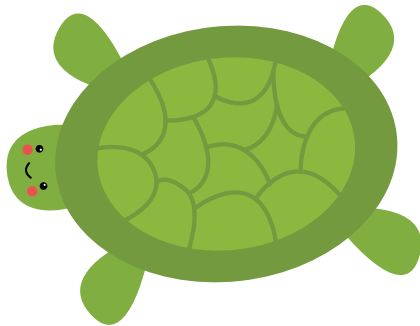
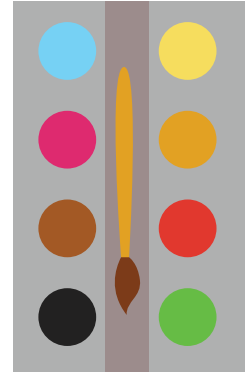
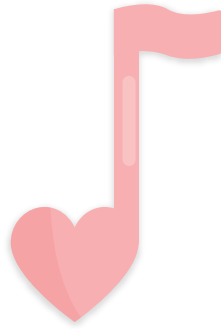
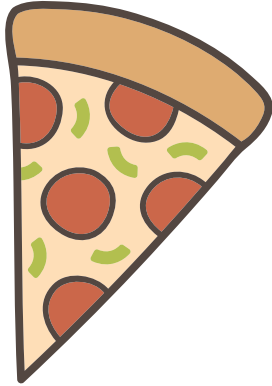

Circle the Square Things

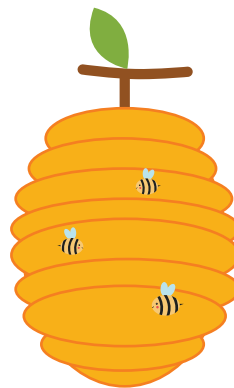
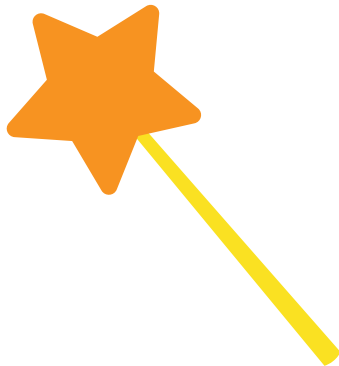
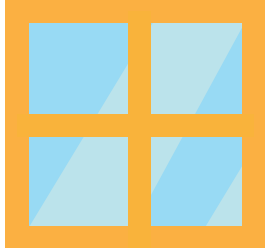

Circle the Rectangle Things

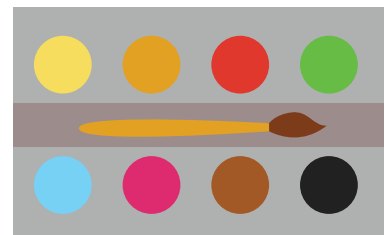
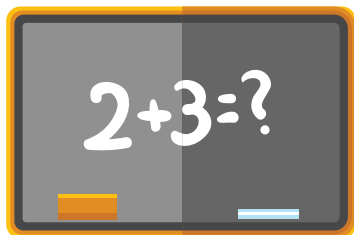
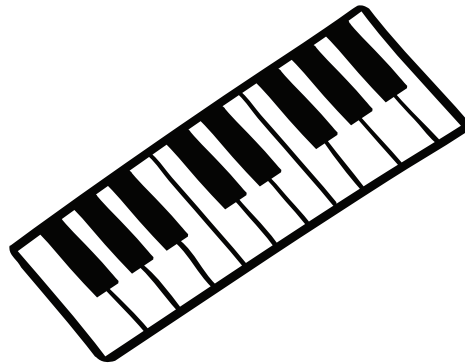
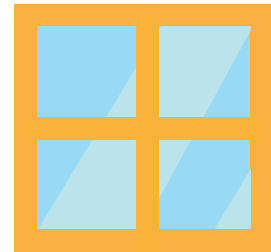
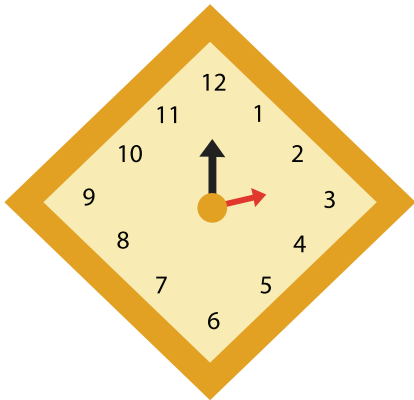
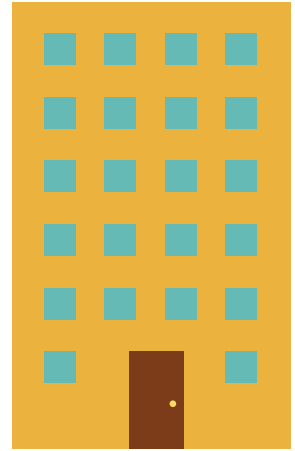
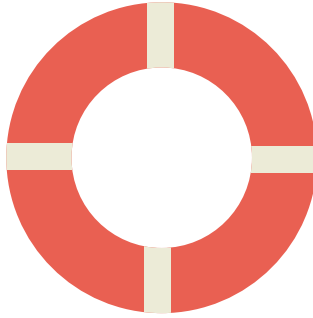
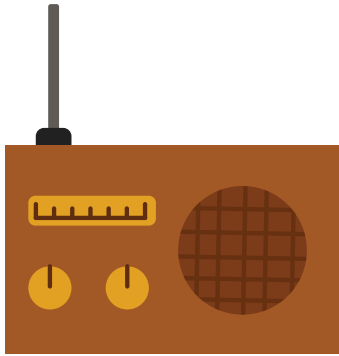

Circle the Oval Things

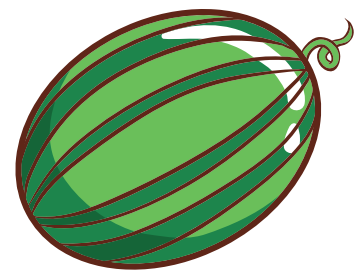
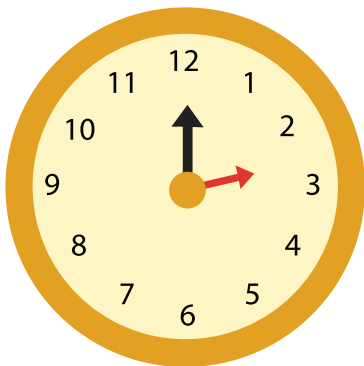
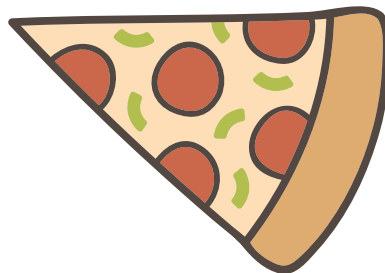
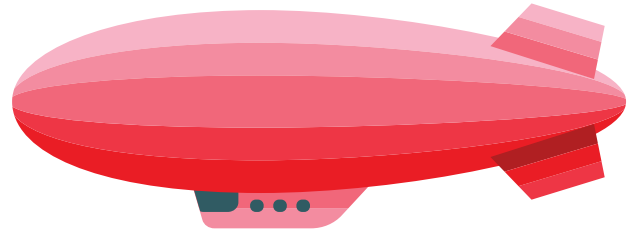
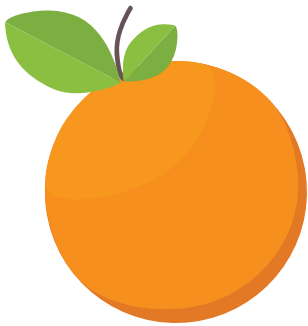
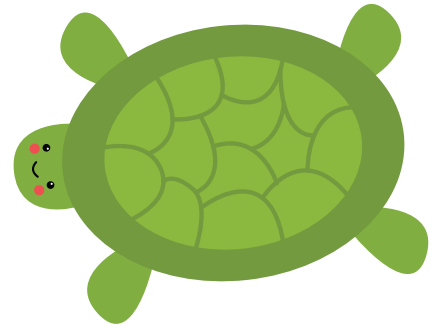
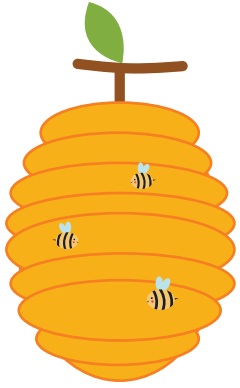

Circle the Diamond Things

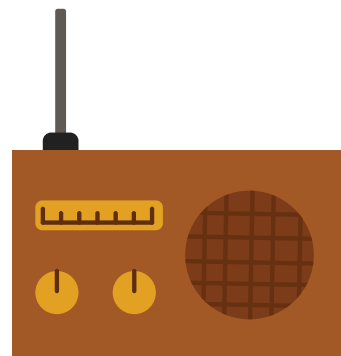
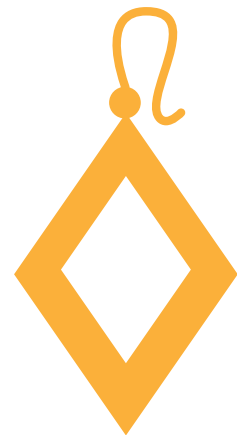
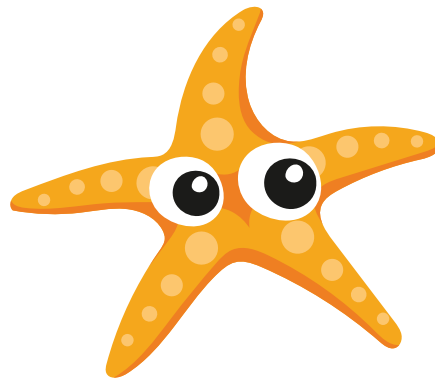
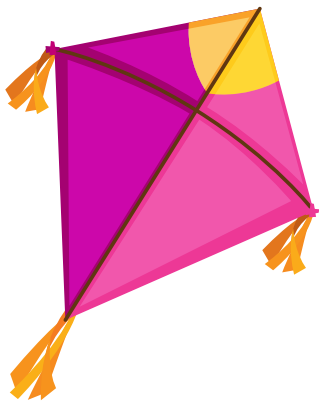
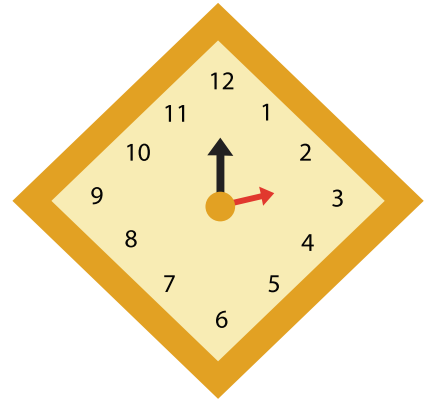

Circle the Hexagon Things

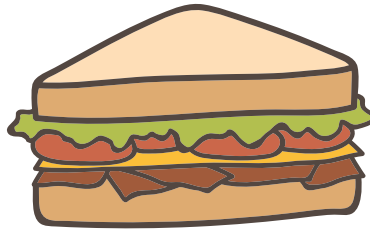

Circle the Star Things!

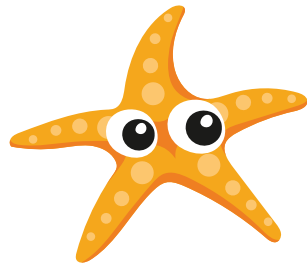
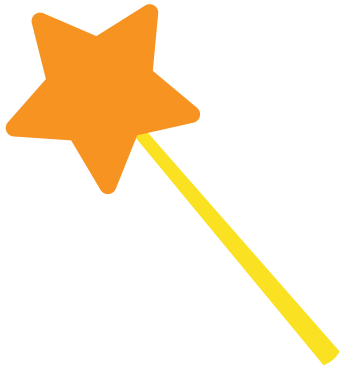

Circle the Heart Things

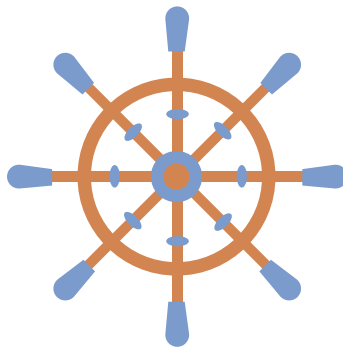
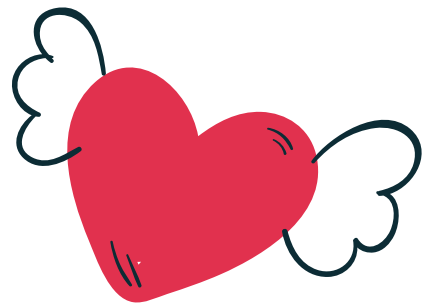
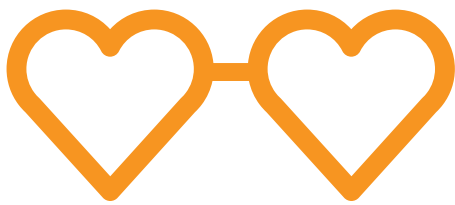
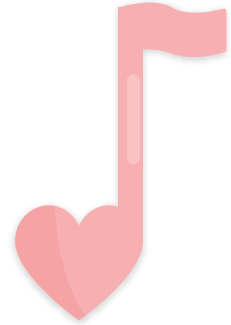
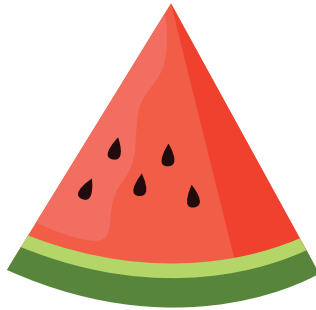

Match Name with Shape

Triangle



Oval

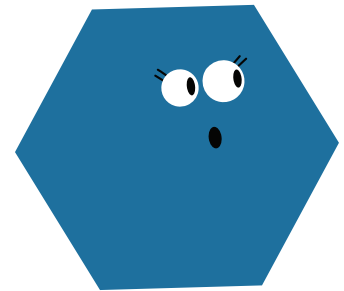

Star



Circle

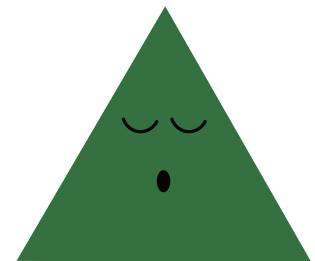

Hexagon

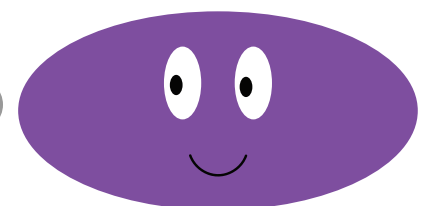

Match Name with Shape

Square

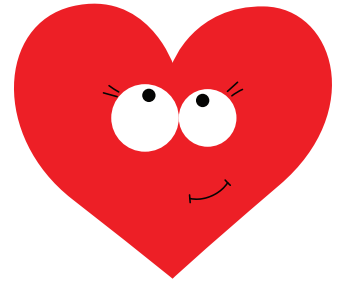

Diamond

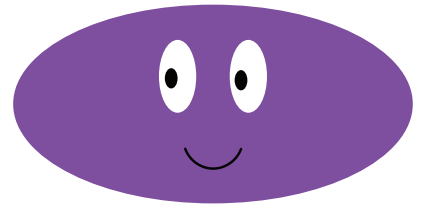

Heart

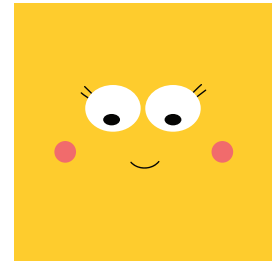

Rectangle

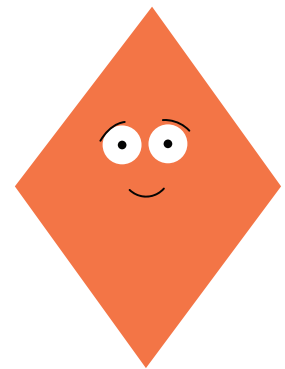

Oval



Match Name with Shape

Circle ●

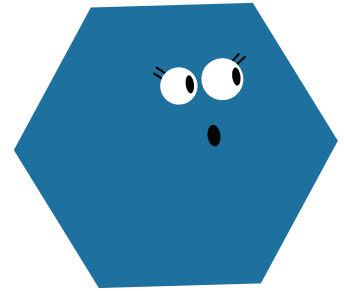

Rectangle ●

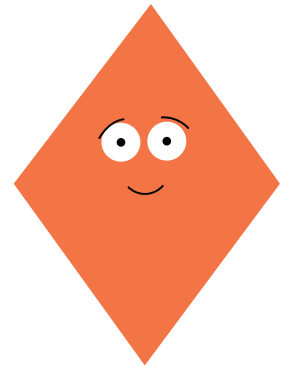

Hexagon ●

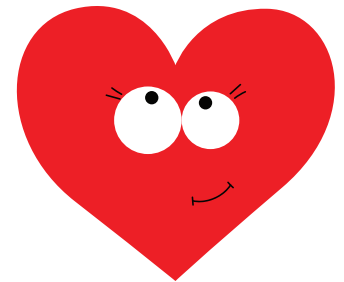

Diamond ●



Heart ●

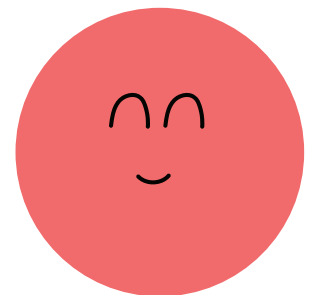

Match Name with Shape

Star ●

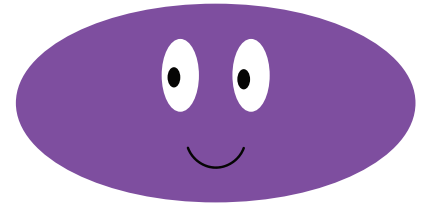

Triangle ●



Oval ●

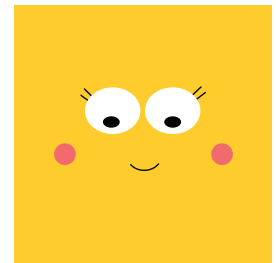

Square ●



Rectangle ●

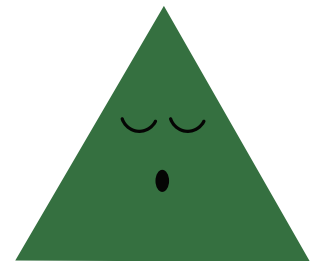

Match Name with Shape

Diamond ●

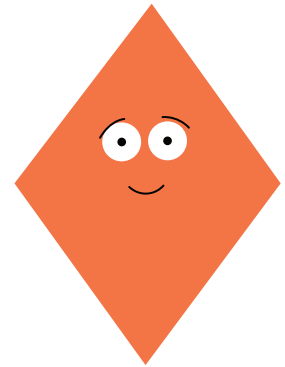

Star ●

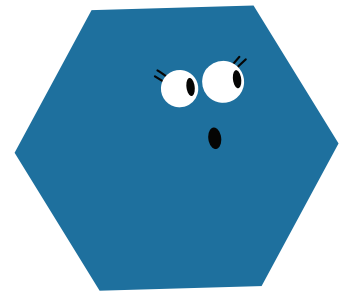

Hexagon ●

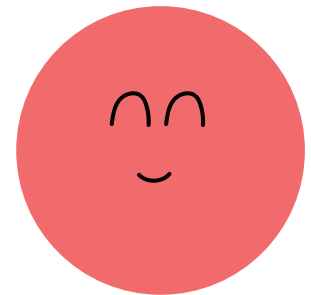

Circle ●

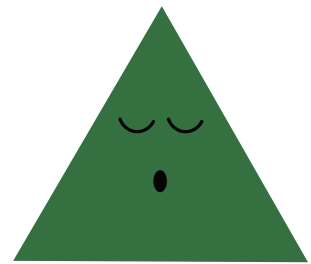

Triangle ●



Match Shape with Picture

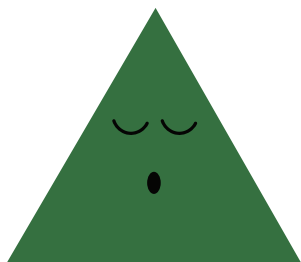
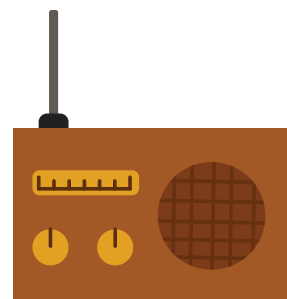
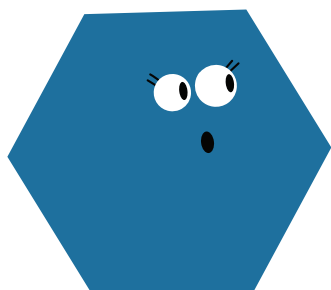
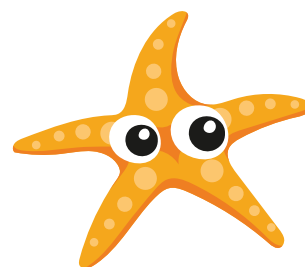
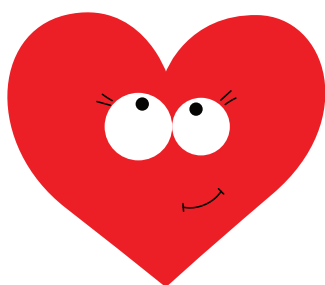
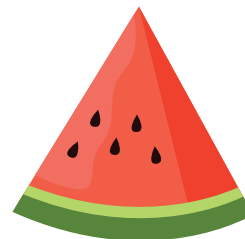

Match Shape with Picture

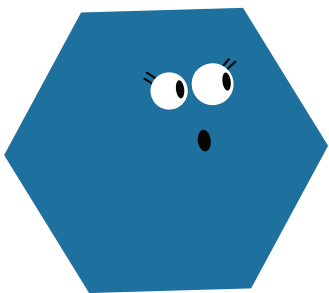
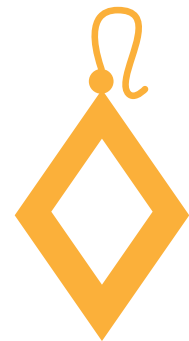
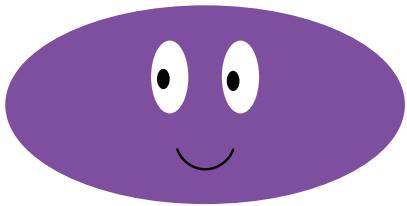
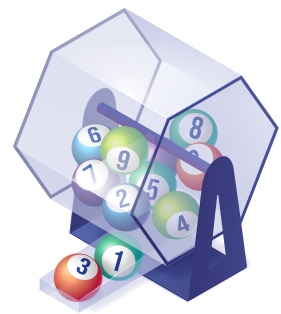
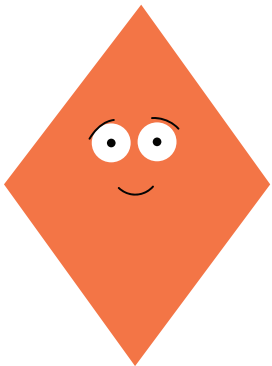
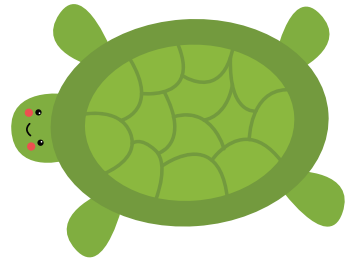
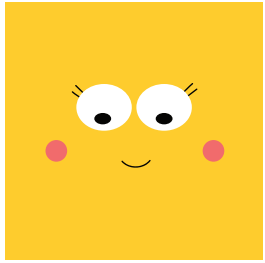

Match Shape with Picture

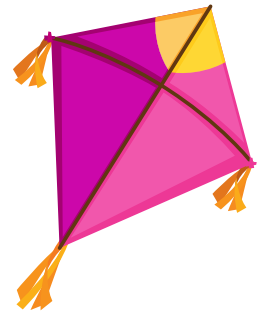
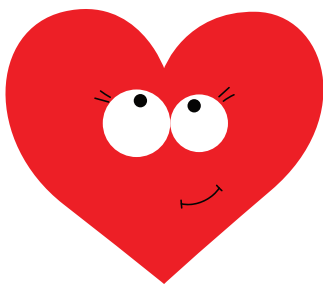
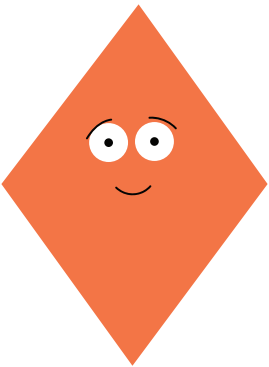
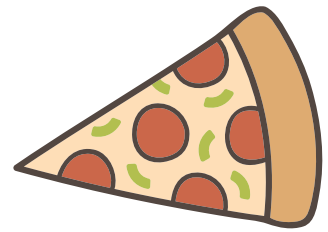
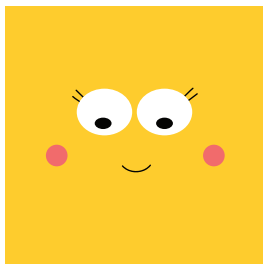
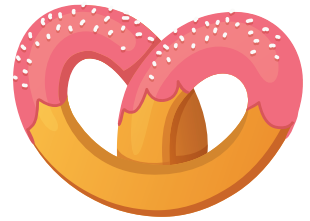
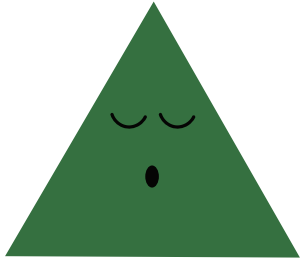

Match Shape with Picture

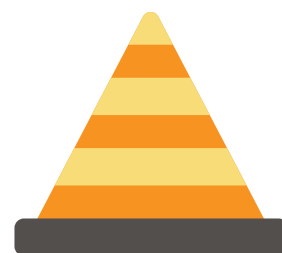
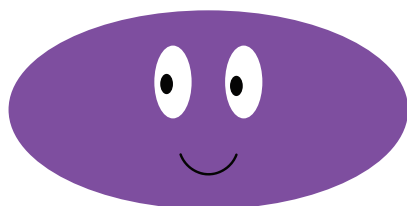
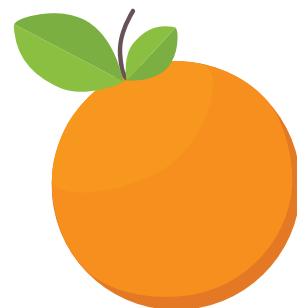
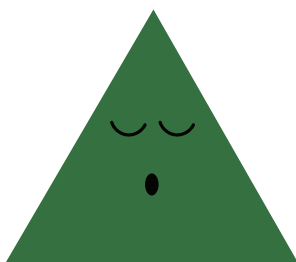
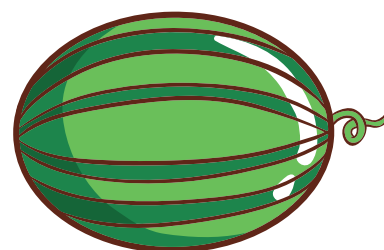
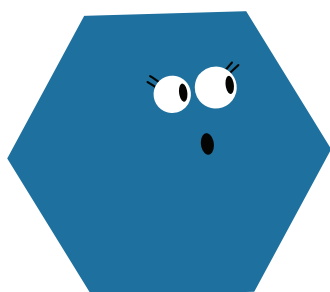
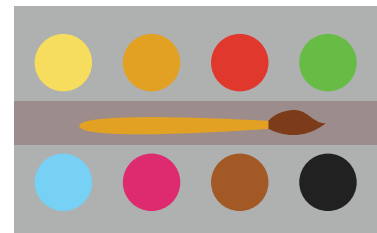
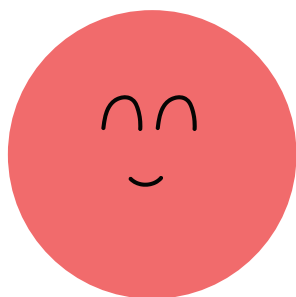

Match Shape with Picture

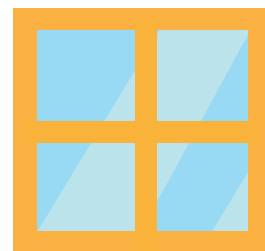
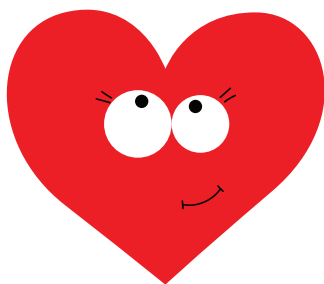
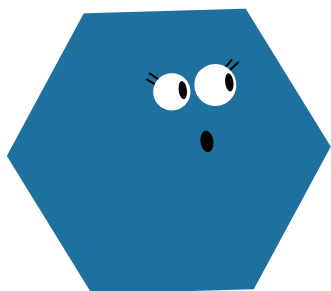
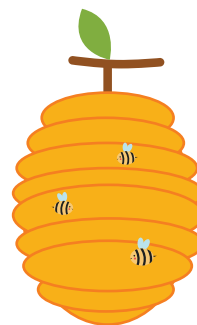
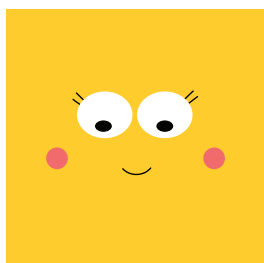
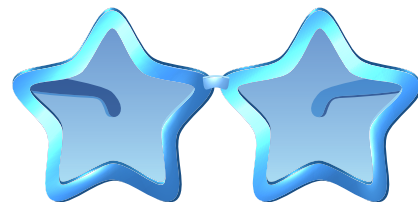
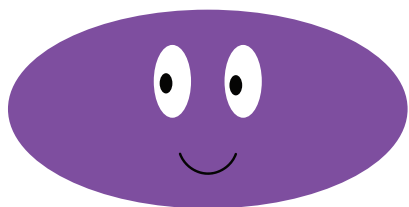

Match Shape with Shadow

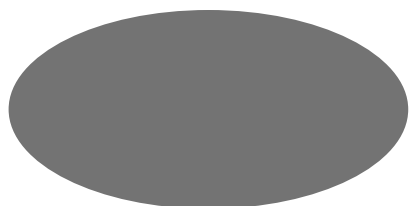
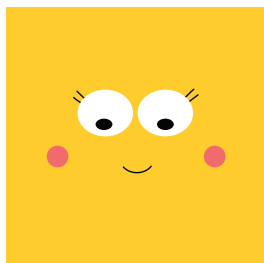
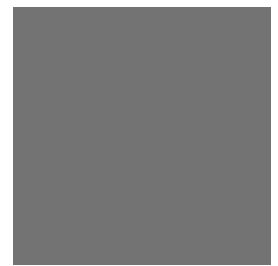
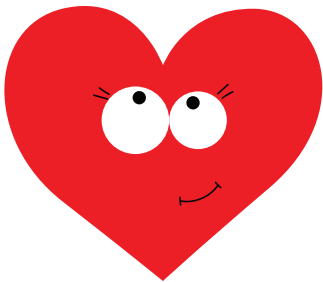
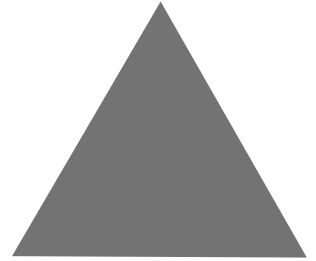
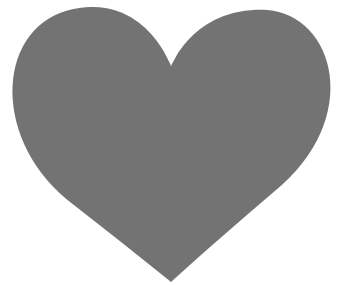
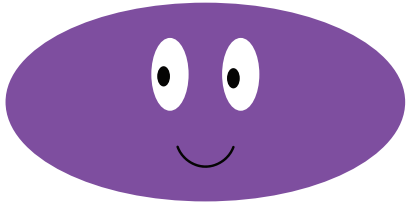
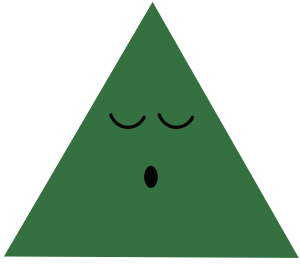

Match Shape with Shadow

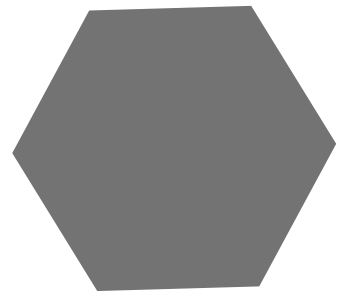
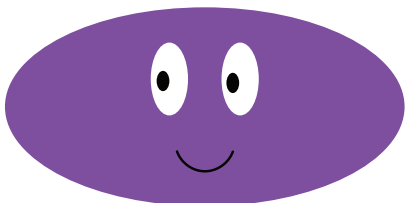
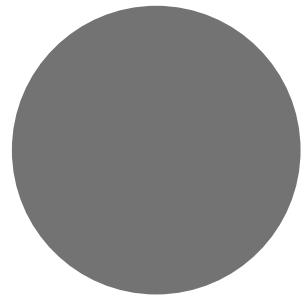
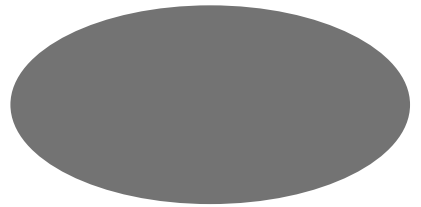
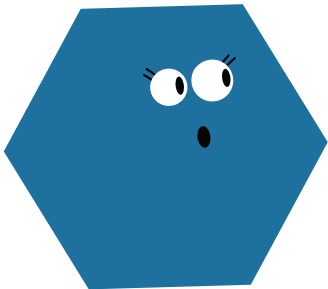
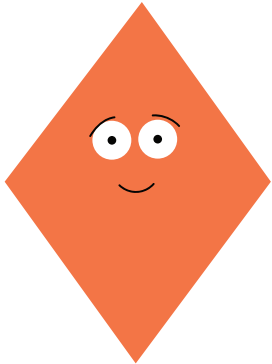
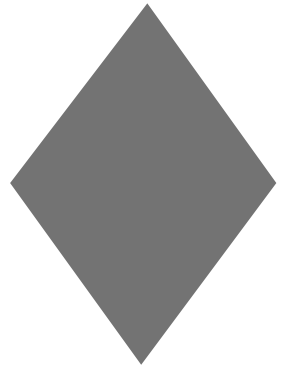

Match Shape with Shadow

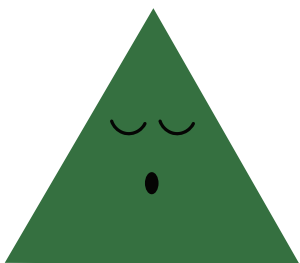
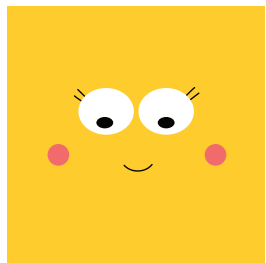
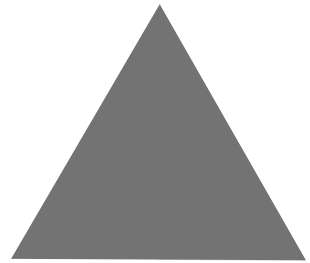
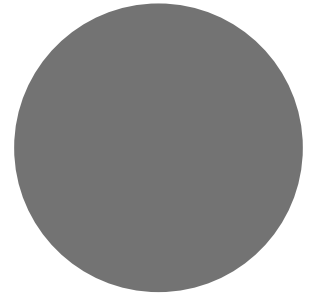

Match Shape with Shadow

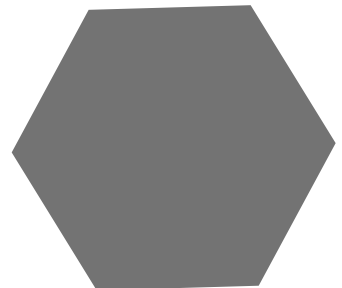
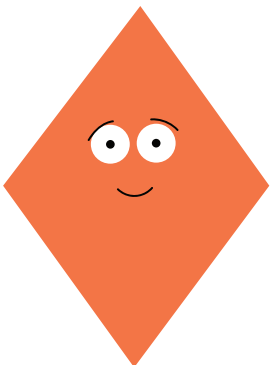
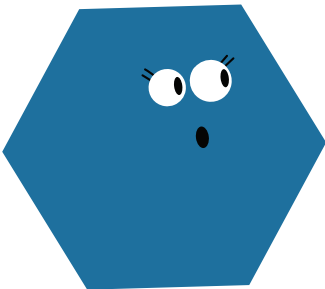
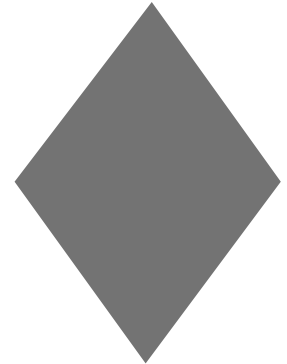
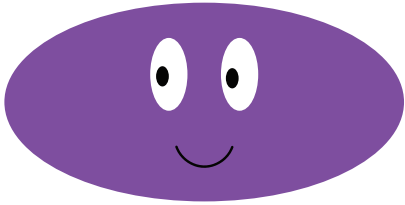
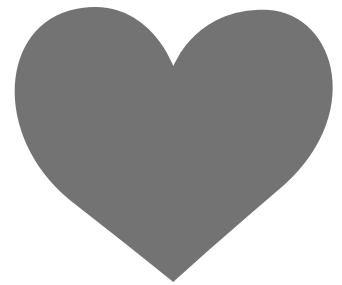
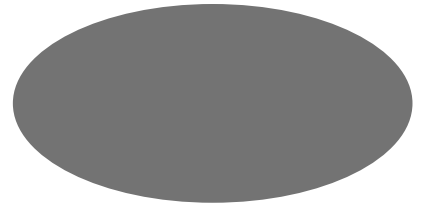

Match Shape with Shadow

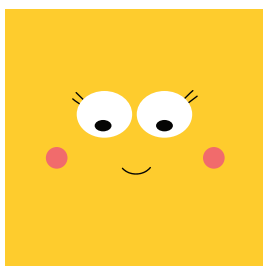
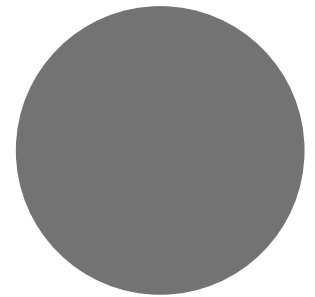
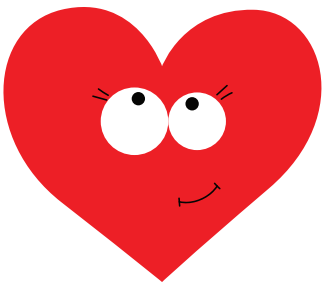
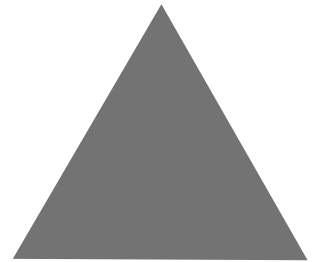
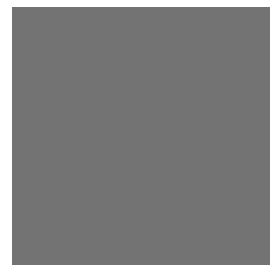
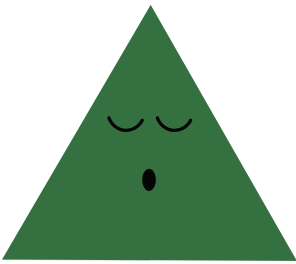
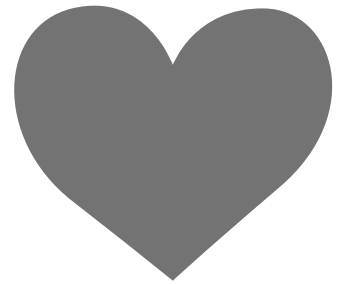
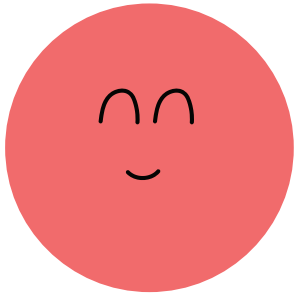

Cut and Paste Shapes

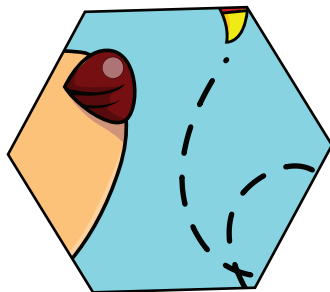
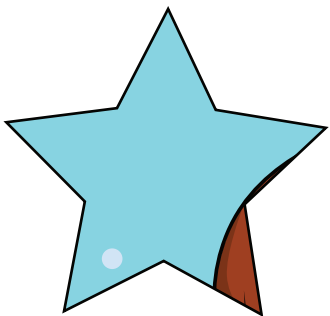

Cut and Paste Shapes

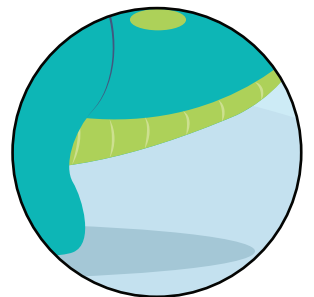
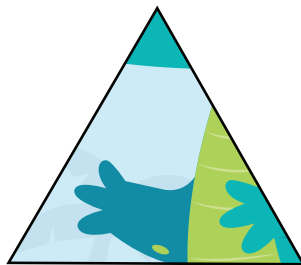
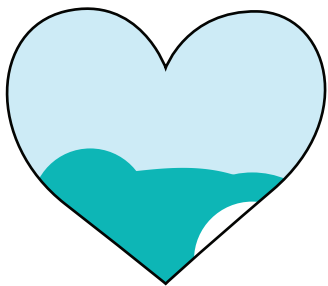
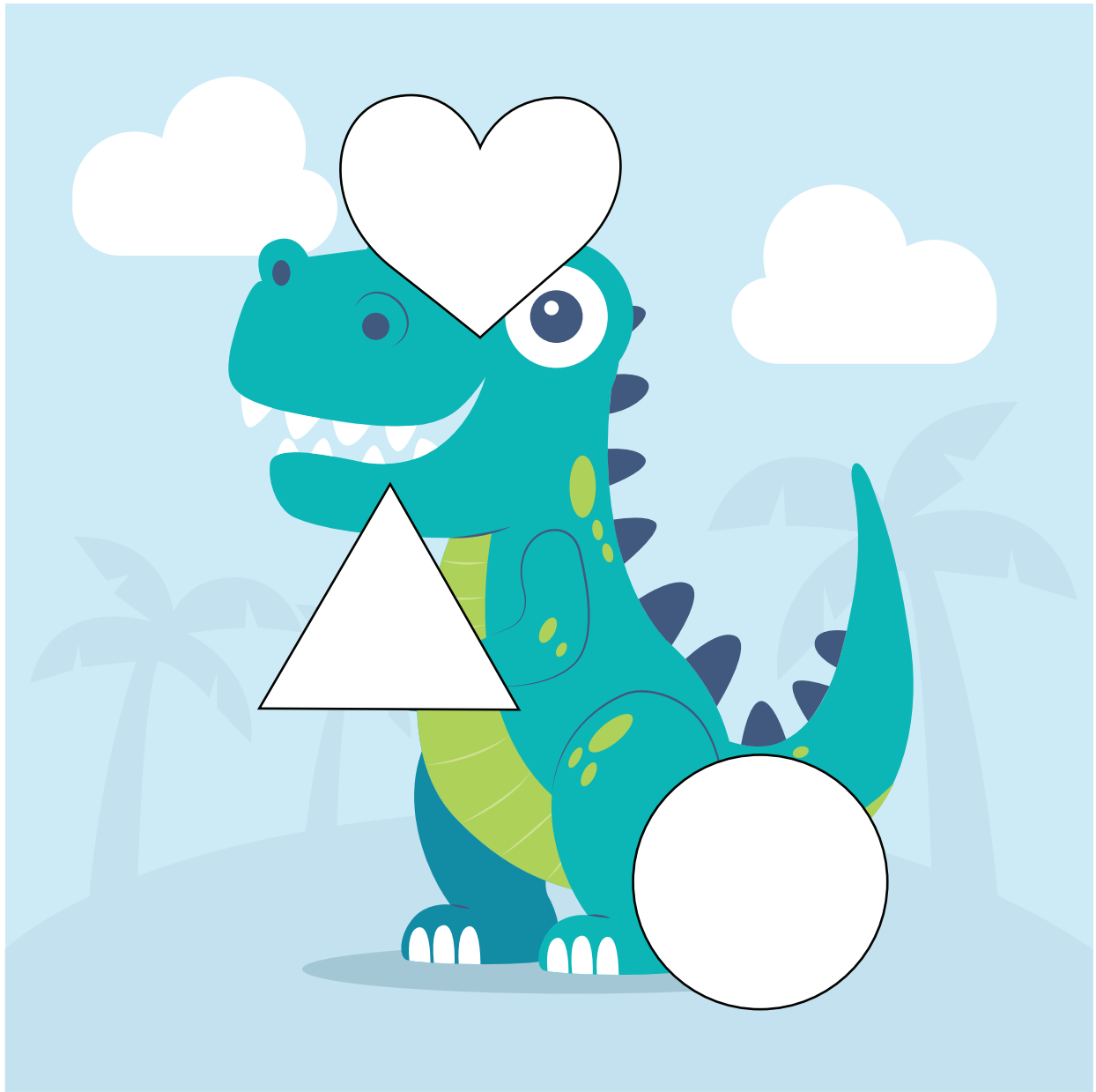

Cut and Paste Shapes

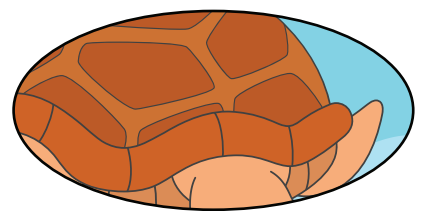
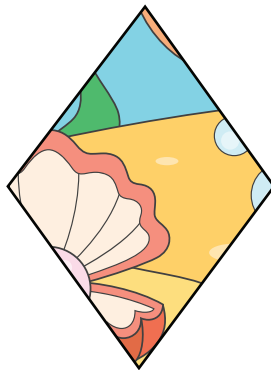
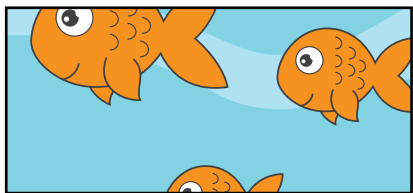
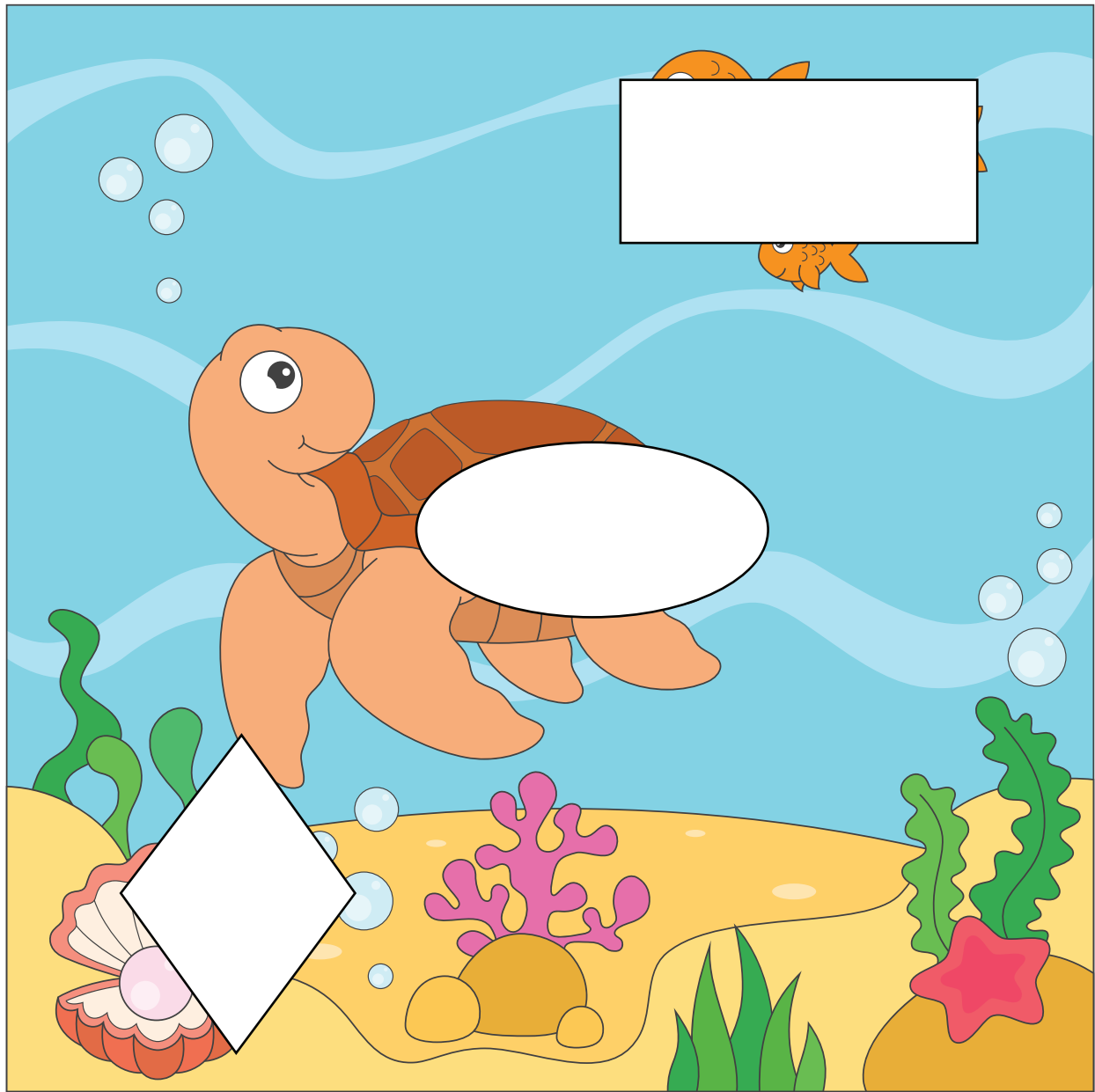

Cut and Paste Shapes

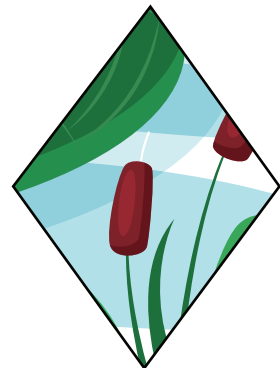
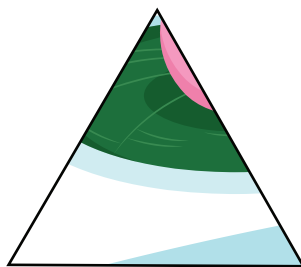

Cut and Paste Shapes

